Subject: I want to add gigabit LAN...

Posted by [Carrierll](#) on Thu, 15 Nov 2007 17:55:14 GMT

[View Forum Message](#) <> [Reply to Message](#)

Heya. I now have three Gigabit LAN capable PCs (Well, between the family) and I was thinking it would be nice to actually use this feature, as they are currently stuck on base 100. (Setup as in the first picture)

Now, for just £35, I could get a PCI Gigabit LAN card, some more cables and a 5 port gigabit switch, and change the LAN structure to look like this...

Will that work? For the most part, my Mum and sister use the wireless LAN via their laptops to hog the bandwidth (grr) but they don't need the high speed LAN connection for gaming etc.

As for the 3 PCs that would be on the Gigabit LAN, they are all high-end and we play on them the whole time.

The home server is that SKT 478 thing I have -

2.0 Ghz P4, 1.5 GB RAM, 40 GB HDD

The server would be connected to a USB hard disk containing all the music and stuff, it would only be the people on the gigabit LAN that would actually use that. In that diagram, at least two of the PCs on the gigabit part would be playing ren at the same time, so how would this setup affect that?

Any alternative suggestions are welcome, if you need that server to be using Linux or something, that's also do-able.

File Attachments

1) [CurNetworkDiag.jpg](#), downloaded 921 times

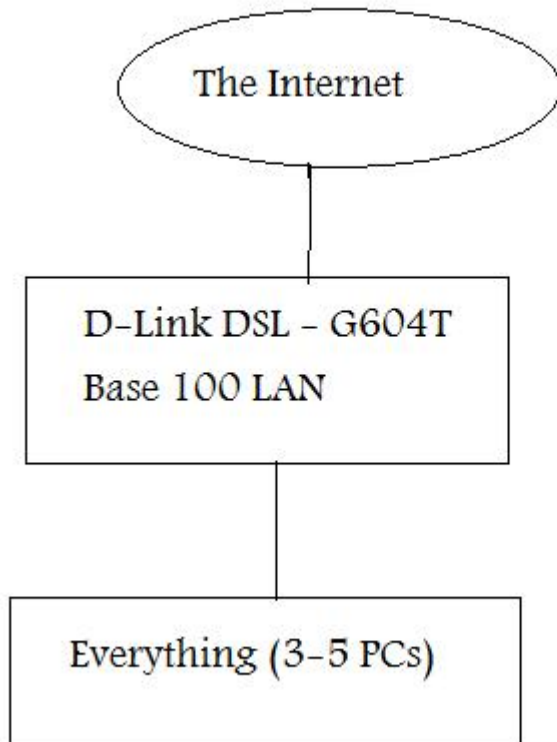

Subject: Re: I want to add gigabit LAN...

Posted by [cmatt42](#) on Fri, 16 Nov 2007 03:28:03 GMT

[View Forum Message](#) <> [Reply to Message](#)

If you want performance, put the gigabit machines higher in the chain, and the 100Mbps/wireless connections as the secondary connections.

Besides, you probably wouldn't notice the difference anyway. Even with several transfers running at once, I've never even used half of the bandwidth on my 100Mbps.

Subject: Re: I want to add gigabit LAN...

Posted by [Carrierll](#) on Fri, 16 Nov 2007 09:40:26 GMT

[View Forum Message](#) <> [Reply to Message](#)

cmatt42 wrote on Fri, 16 November 2007 03:28 If you want performance, put the gigabit machines higher in the chain, and the 100Mbps/wireless connections as the secondary connections.

Besides, you probably wouldn't notice the difference anyway. Even with several transfers running at once, I've never even used half of the bandwidth on my 100Mbps.

Even with a three player LAN game, two of the players listening to music and some file transfers

on top?

Subject: Re: I want to add gigabit LAN...

Posted by [Olaf van der Spek](#) on Sat, 24 Nov 2007 09:54:39 GMT

[View Forum Message](#) <> [Reply to Message](#)

[quote title=Carrierll wrote on Fri, 16 November 2007 10:40]cmatt42 wrote on Fri, 16 November 2007 03:28Even with a three player LAN game, two of the players listening to music and some file transfers on top?

Did you encode your audio at a rate of mbit/s instead of kbit/s?
File transfers? From the internet? Is your internet > 30 mbit/s?

Subject: Re: I want to add gigabit LAN...

Posted by [Carrierll](#) on Sat, 24 Nov 2007 11:48:06 GMT

[View Forum Message](#) <> [Reply to Message](#)

No, that's all network. I enocde my music at 128 or 192 KBPS, but that could be three of us at once, probably two. Then the game, and the file transfers would be ISO's of game disks (we refuse to buy more than one copy so we can play a LAN game...) and things like that, all between the three Gigabit PCs and the server.

my internet is a "subjective rating - awesome"ly crap 1.3 Mbits. I could knock my local exchange down with a stick....

Subject: Re: I want to add gigabit LAN...

Posted by [Caveman](#) on Sat, 24 Nov 2007 14:16:29 GMT

[View Forum Message](#) <> [Reply to Message](#)

Since your home server is connected to a USB HDD where all your server data will be stored, your 1Gbps would be pointless as USB cannot transmit anywhere near that. You wouldn't notice any difference whatsoever. You can only read/write as fast as your HDDs let you.

For example you could have a 100Gbps internet connection which is great but you couldn't use it because your HDD wouldn't be able to keep up with the amount of data.

Basically it would be like having a Nvidia 8800GTX in a P4 Celeron 1.8 with a crappy mobo. Totally useless.
